

# Voice Evacuation

**Zeta**<sup>®</sup>  
ALARMS LIMITED



UL864  
UL1711

# Voice Evacuation One Out - All Out System

**Zeta**<sup>®</sup>  
ALARMS LIMITED

Ideal for  
Schools or University Campus  
Military Bases, Large open Areas  
Shopping Centres etc.....



UL864  
UL1711

# Product Range

Main Control Panel

Designed to be the voice evacuation extension of an existing fire alarm system.

Integration is quick and easy, triggering from a single primary connection of an alarm or sounder circuit from the FACP

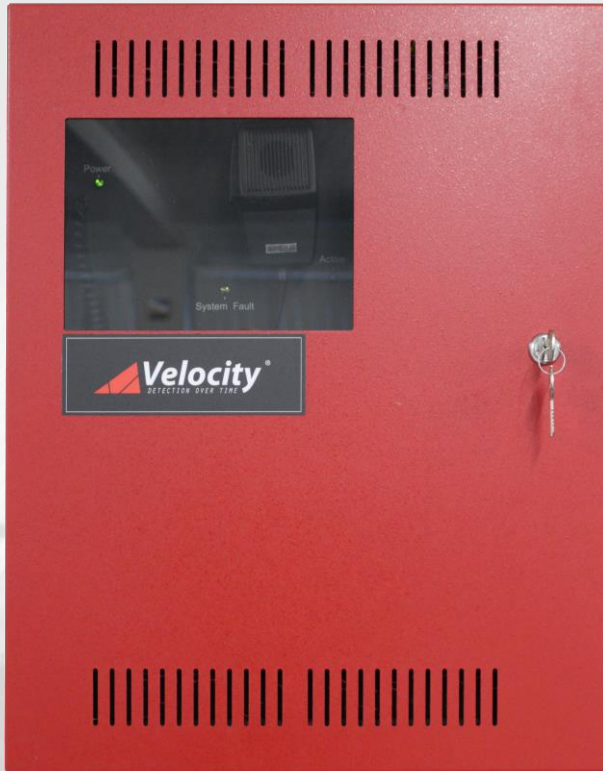

ZT-MNS-100BAS  
Voice Evacuation Panel



Fire Alarm Control Panel



# Product Range

## Main Control Panel

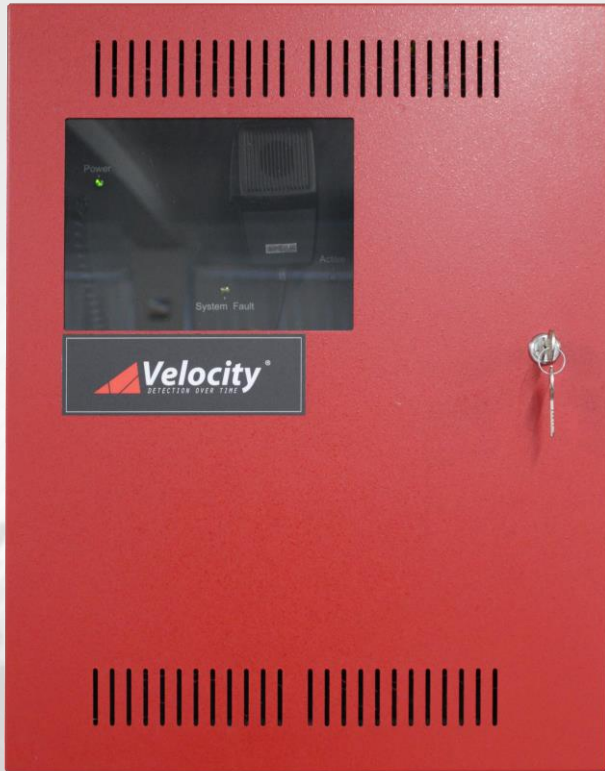

## Features

Highly Efficient Class D Digital Audio Amplifier

Audio 100 watt; 25 Vrms (with optional 70 Vrms)

Built-in Microphone

Aux audio inputs for paging, background music or remote system control

2 Standard Pre-loaded Messages

120v / 240v - 60Hz; 5A Nominal Input

4 Speaker Circuits – Class A or Class B wiring

Primary Line 1



Power Limited to 100w  
(or 60w if any additional speaker lines are also used)

Speaker Line 2



Power Limited to 25w

Speaker Line 3



Power Limited to 25w

Speaker Line 4



Power Limited to 25w

**Combined total must not exceed 100 watts**

## ZT-MNS-100BAS Voice Evacuation Panel

# Product Range

Main Control Panel

Additional Audio Power

## Need More Power ???

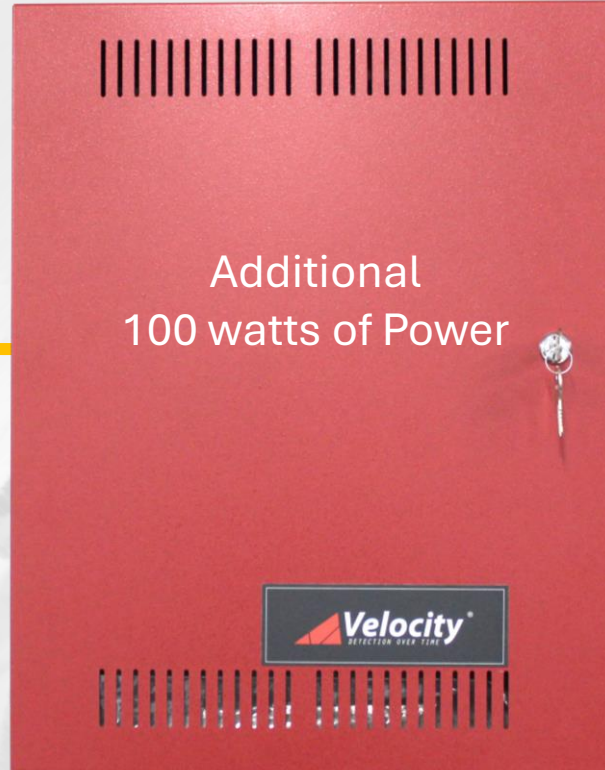
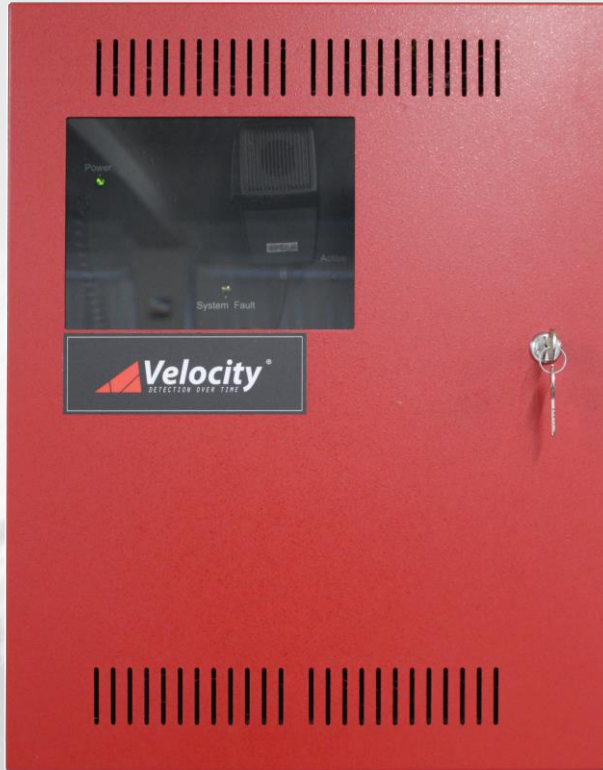

### Features

- Highly efficient Class D Digital Audio Amplifier
- Supervised Dry Contact Closure Primary Activation Input
- 120v / 240v - 60Hz; 5A Nominal Input
- 4 Speaker Circuits – Class A or Class B wiring

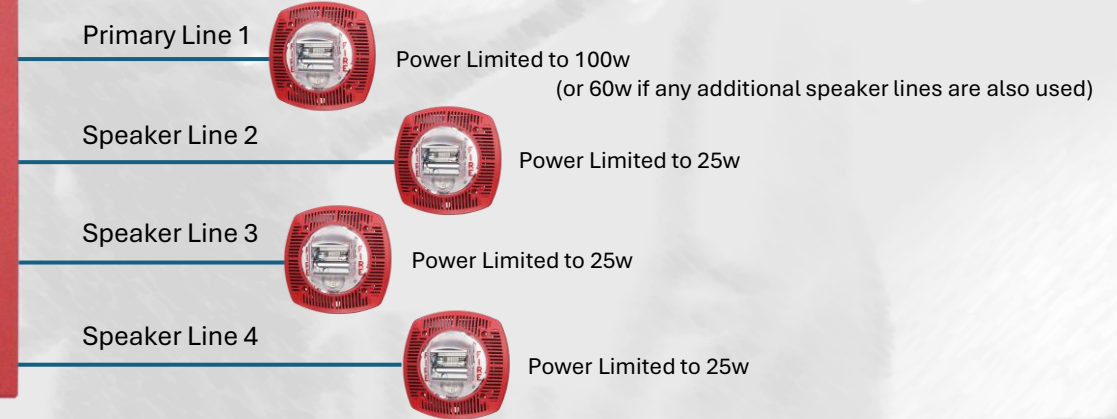

**Combined total must not exceed 100 watts**

ZT-MNS-100BAS  
Voice Evacuation Panel

ZT-MNS-100APB  
Audio Power Booster Unit

# Product Range

Main Control Panel

Additional Audio Power

## Need Even More Power ???

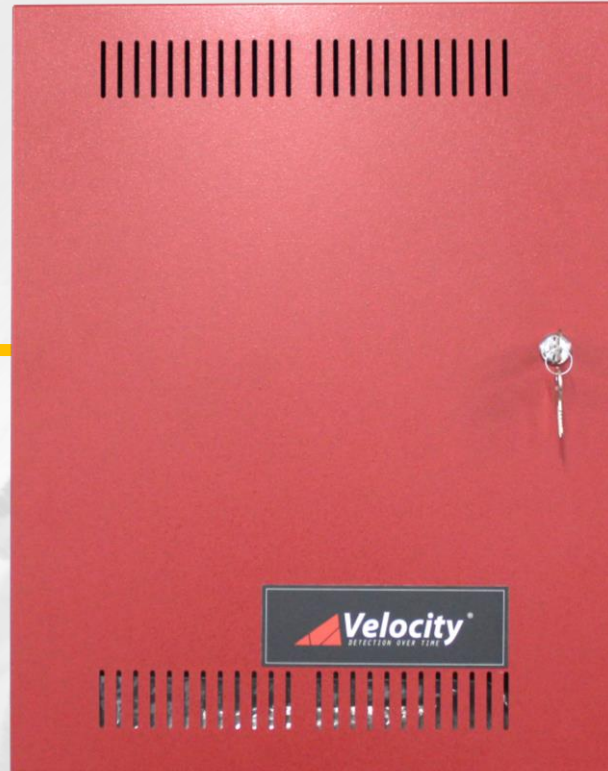
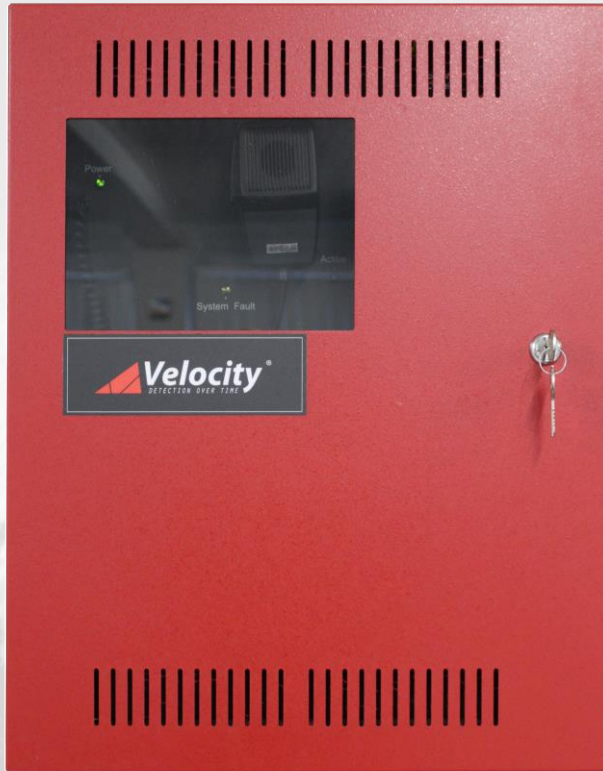

ZT-MNS-100BAS  
Voice Evacuation Panel

ZT-MNS-100APB  
Audio Power Booster Unit

ZT-MNS-100APB  
Audio Power Booster Unit

ZT-MNS-100APB units can be daisy-chained for virtually unlimited power output for coverage of large areas

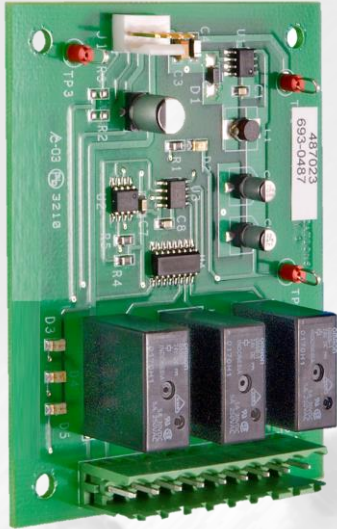

The ZT-MNS-3-REL relay card provides 3 x Form-C relay outputs to the ZT-MNS-100BAS Voice Evacuation Panel and ZT-MNS-100APB Audio Power Booster Unit

### Features

3 Outputs – Active, Trouble and a spare

Each Output is rated for 30Vdc and 3 Amps

Primary use to send an Active Alarm output signal to the next linked ZT-MNS-100APB Audio Power Booster Unit.

### ZT-MNS-3-REL

Common Alarm & Trouble  
3-Relay Card

# Product Range



The ZT-MNS-3-REL relay card has a designated mounting area inside the ZT-MNS-100BAS and ZT-MNS-100APB enclosures for ease of installation

1 x ZT-MNS-3-REL is required per panel / unit that is sending a triggering output

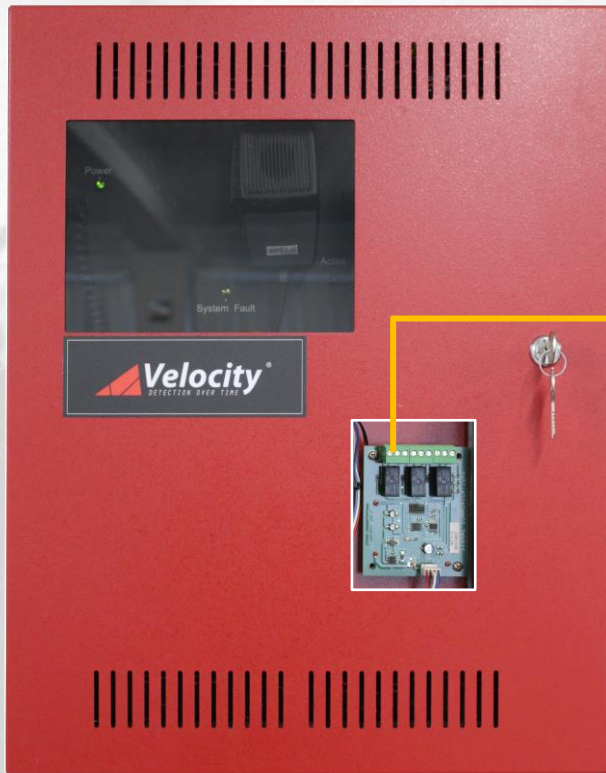

ZT-MNS-100BAS  
Voice Evacuation Panel

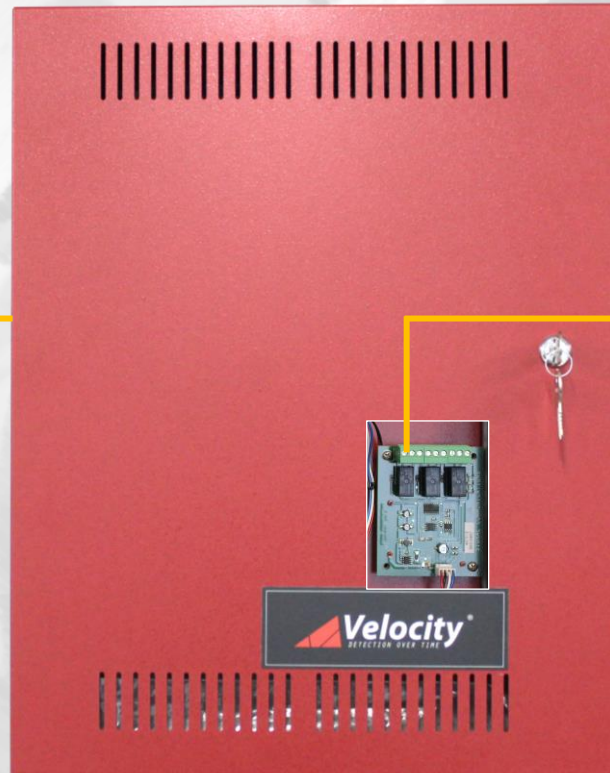

ZT-MNS-100APB  
Audio Power Booster Unit



ZT-MNS-100APB  
Audio Power Booster Unit



ZT-DVS-RM/B  
Remote Microphone

A remote microphone for use with a ZT-MNS-100BAS system

## Features

1 x Remote microphone can be used with ZT-MNS-100APB Audio Booster Unit  
(ZT-MNS-100BAS Control Panel has one already included as standard)

Can be located up to 100ft away from the Audio Booster Unit

Provides paging with live override of the pre-recorded message or alert tone

The microphone and interconnecting wires are supervised

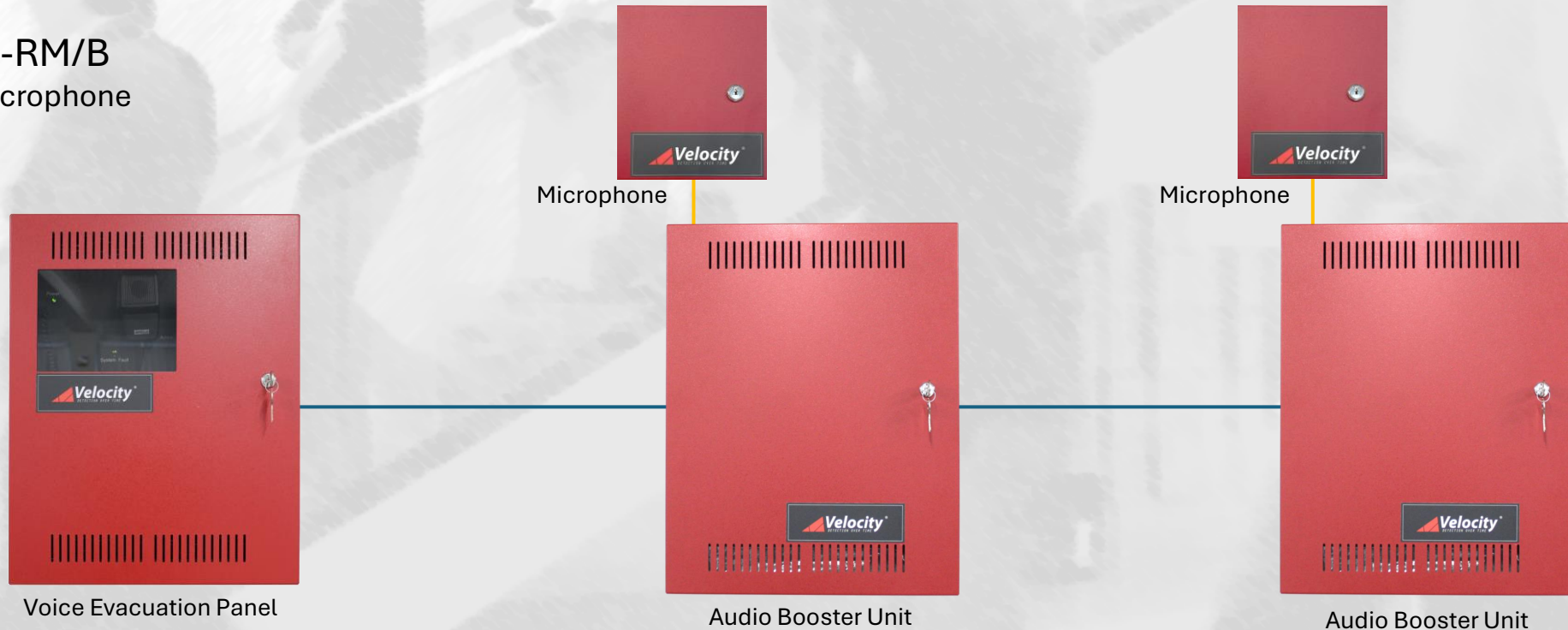

Transformer that converts the standard 25Vrms speaker output to 70Vrms

## Features

25Vrms to 70Vrms audio conversion for long wire runs

**Input** - 25Vrms 100 watts continuous    **Output** - 70Vrms audio 100 watts continuous

Five conductor connection between the control panel / audio booster unit to the ZT-MNS-70V-XFMR

Mounts conveniently near the control panel / audio booster panel



ZT-MNS-70V-XFMR  
70 Vrms Transformer Kit



## Product Range

### Indoor Speaker / Speaker with Strobe



**ZT-SSPKCLP\***  
Universal Mount Speaker

#### Features

Speaker only

Compatible for 25Vrms and 70Vrms

Field Selectable Power Taps – 1/8w, 1/4w, 1/2w, 1w, 2w & 4w

Universal Mount- Wall mount or Ceiling mount

Available in Red or White

Nominal Voltage 24 Vdc



**ZT-SSPK24CLP\***  
Ceiling Mount Only - Speaker / Strobe

#### Features

Speaker with Strobe

Compatible for 25Vrms and 70Vrms

Field Selectable Power Taps – 1/8w, 1/4w, 1/2w, 1w, 2w & 4w

24Vdc Field Selectable Candela Outputs – 15, 30, 75, 95 & 110

Ceiling mount only

Available in Red or White

Nominal Voltage 24 Vdc

#### Product Listings

SIGNALING



- ANSI/UL 1480, ANSI/UL 1971 and ANSI/UL 2043 Listed
- CAN/ULC S526 and/or CAN/ULC S541 Listed
- CSFM: 7320-0569:0137
- MEA: 580-06-E Vol. 3

## Product Range

Indoor Speaker / Speaker with Strobe continued.....



ZT-SSPK24WLP\*

Wall Mount Only - Speaker / Strobe

### Features

Speaker with Strobe

Compatible for 25Vrms and 70Vrms

Selectable Input Watts – 1/8w, 1/4w, 1/2w, 1w, 2w & 4w

Selectable Candela Outputs – 15, 30, 75, 95 & 110

Wall mount only

Available in Red or White

Nominal Voltage 24 Vdc

#### Product Listings

SIGNALING



- ANSI/UL 1480, ANSI/UL 1971 and ANSI/UL 2043 Listed
- CAN/ULC S526 and/or CAN/ULC S541 Listed
- CSFM: 7320-0569:0137
- MEA: 580-06-E Vol. 3

## Product Range

### Outdoor Speaker / Speaker with Strobe



ZT-WSSPK24\*

Wall Mount Only - Speaker / Strobe

## Features

Outdoor Speaker with Strobe

Compatible for 25Vrms and 70Vrms

Selectable Input Watts – 1/8w, 1/4w, 1/2w, 1w 2w & 4w

24Vdc fixed 15/75 Candela Output

Wall mount only

Available in Red or White

Nominal Voltage 24 Vdc

### Product Listings

SIGNALING  
C  US  
LISTED



- ANSI/UL 1480 and ANSI/UL 1638 Listed
- CAN/ULC S526 and/or CAN/ULC S541 Listed
- CSFM: 7320-0569:0141

## Product Range

### High Level Audio Output - Indoor / Outdoor Speaker



ZT-SSP-15\*

Universal Mount High Output Speaker

### Features

Indoor / Outdoor Speaker

Compatible for 25Vrms and 70Vrms

Selectable Input Watts – 1/2w, 1w 7.5w & 15w

Durable environmental-resistant metal construction for outdoor or indoor use

Universal mount – Ceiling or Wall mount

Available in Red or Grey

Nominal Voltage 30 Vdc



# Single Line Layout Drawings

## Single Control Panel with 4 Speaker Lines

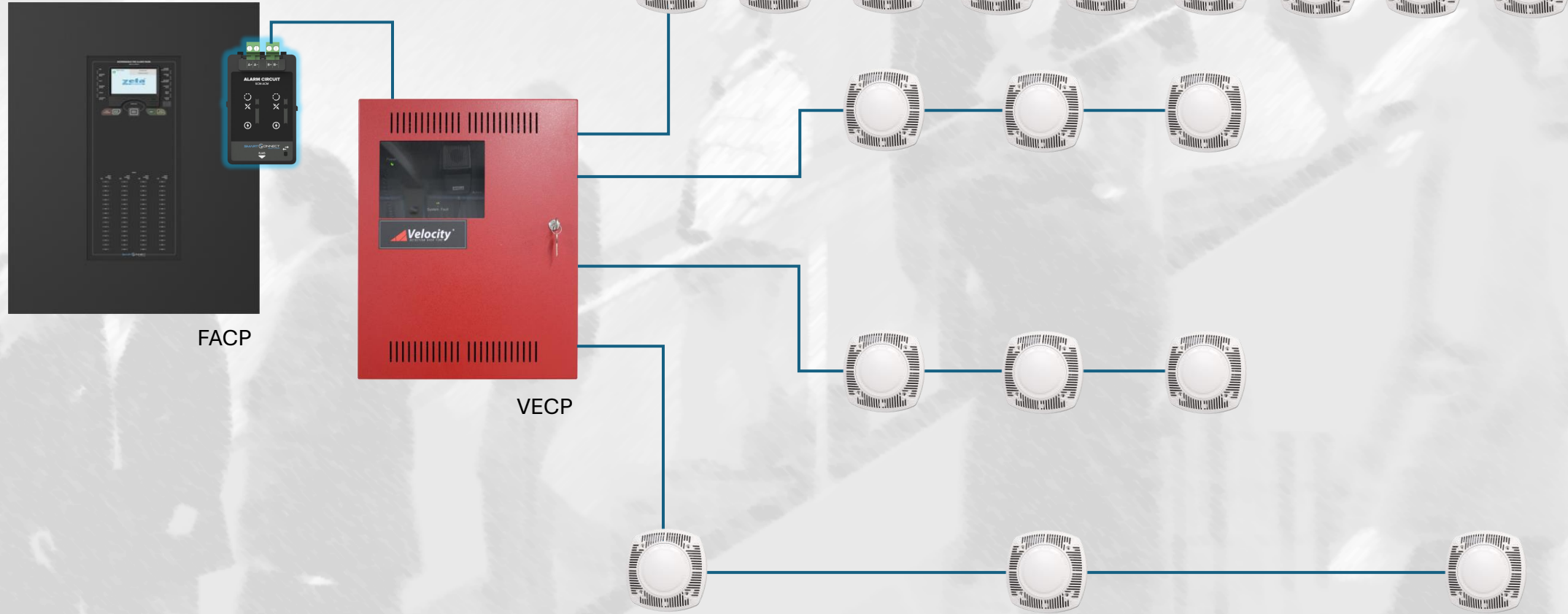

FACP

VECP

# Single Line Layout Drawings

Single Control Panel with the addition of an audio booster unit with microphone

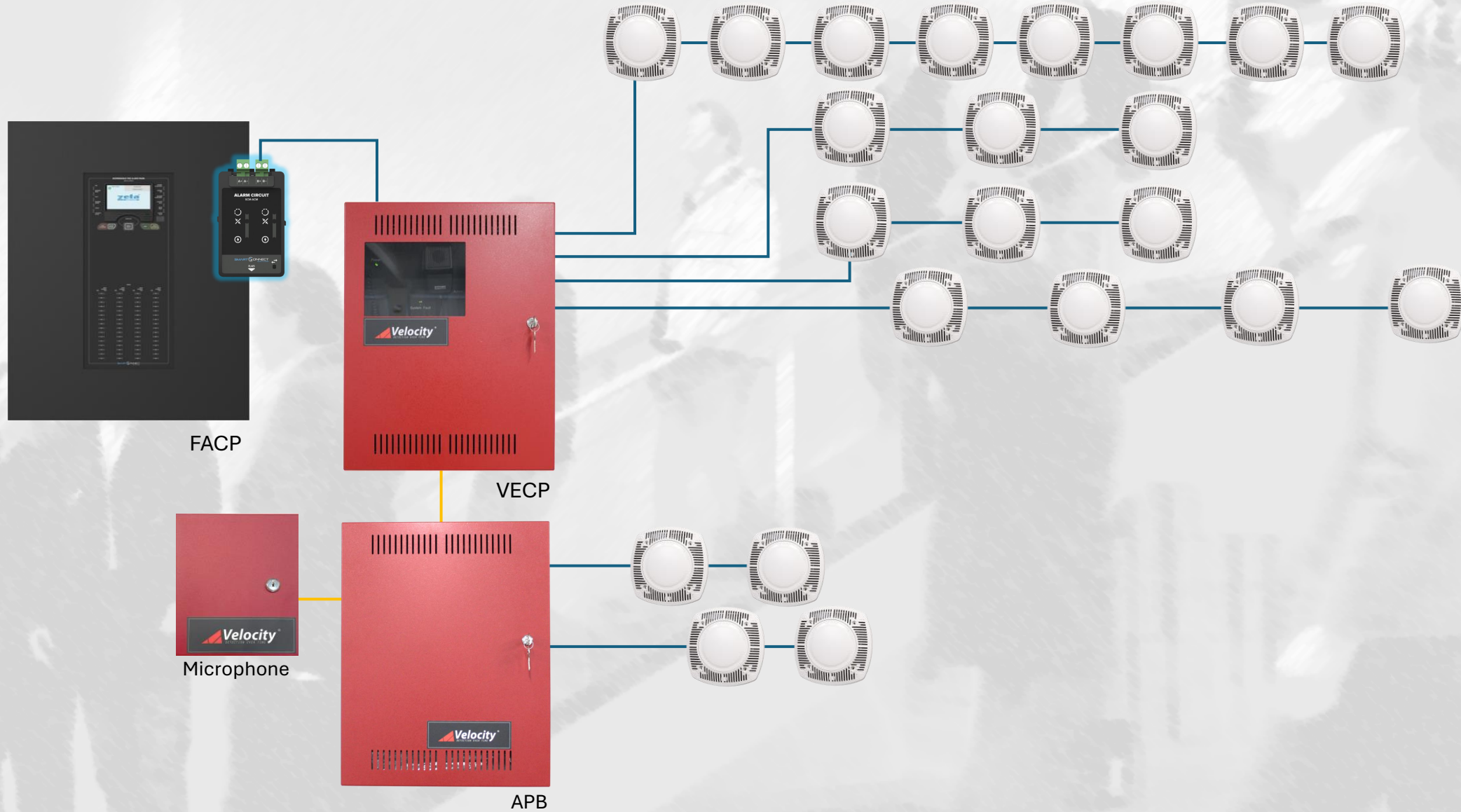

# Single Line Layout Drawings

Single Control Panel with the addition of 2 x audio booster units both with microphone & one with 70 Vrms transformer

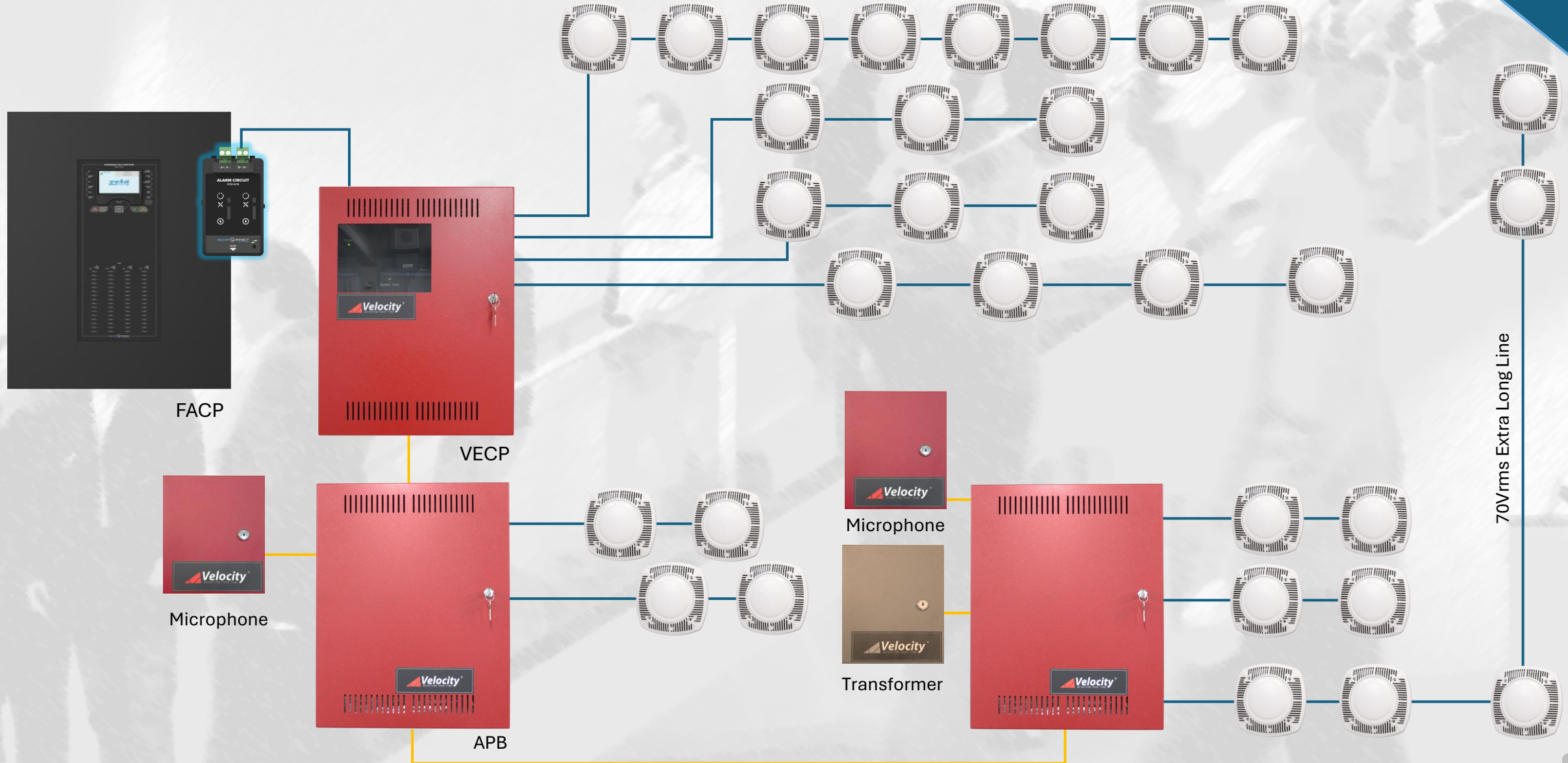

# Thank You For Your Time

**Zeta**<sup>®</sup>  
ALARMS LIMITED



UL864  
UL1711



[www.zetaalarmsystems.com](http://www.zetaalarmsystems.com)